

## E7/... SERIES

**SOLENOID VALVES FOR LIGHT OIL,  
OPERATING PRESSURE UP TO 20 bar.**

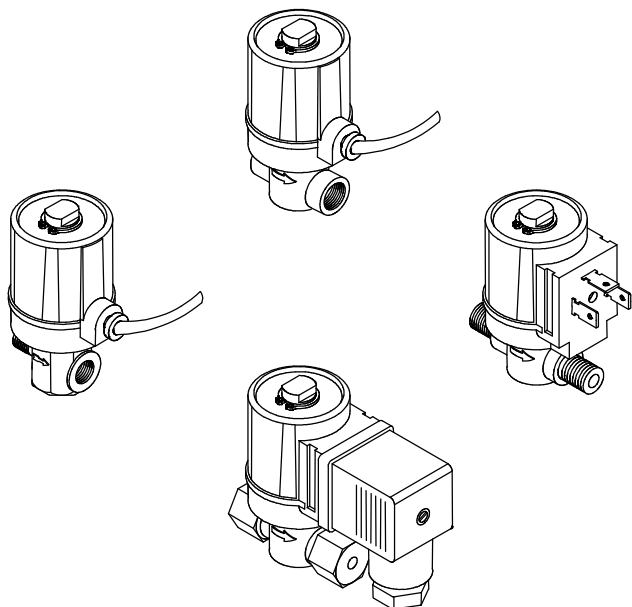

### GENERAL DESCRIPTION

This series solenoid valves are of normally closed type, quick operating, suitable for civil and industrial applications, supplied with alternate or direct current and can be fitted with a wide range of connections which make the assemblage easier and permit to avoid the utilisation of junctions, often onerous and quite unpractical. Versions marked with "U" in their body type reference, even "TS-S" version, are UL approved.

### TECHNICAL FEATURES

Supply voltage (1):	230 V / 50 Hz
Supply voltage for UL approved versions:	220 V / 60 Hz
	120 V / 60 Hz
Operating pressure range:	0 ÷ 20 bar (orifice ø 1,5 mm)
	0 ÷ 18 bar (orifice ø 2 mm)
	0 ÷ 2 bar (orifice ø 4 mm)
Room temperature:	0 ÷ 60 °C
Maximum fuel temperature:	80 °C
Closing and opening time:	≤ 1 s
Consumption:	11 VA
Flow (2):	0.055 m³/h
Weight (2):	230 g
Mounting position:	all
Body:	die-cast brass

- (1) Versions with different supply voltage are available.
- (2) These values are indicative, as with the changing of utilised body type, removals from indicated values can occur.

### OVERALL DIMENSIONS

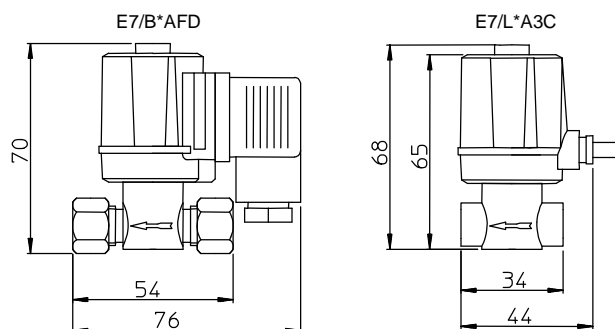

AVAILABLE BODY TYPES

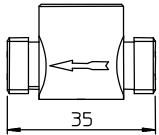
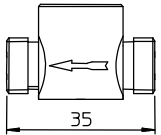
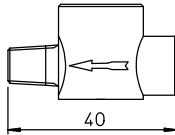
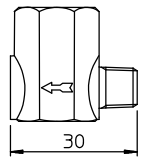
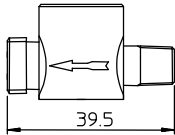
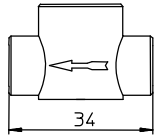
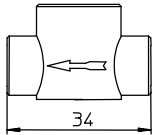
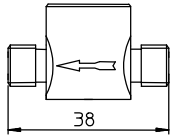
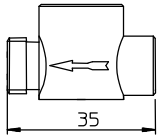
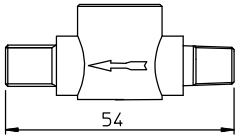
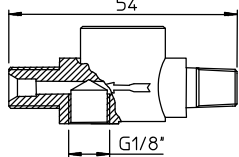
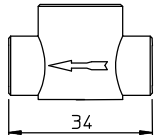
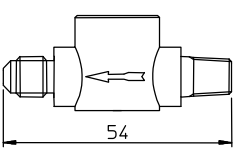
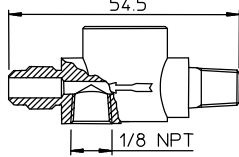
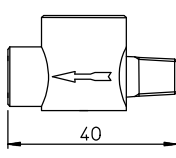
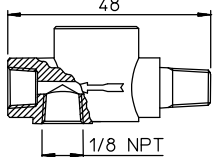
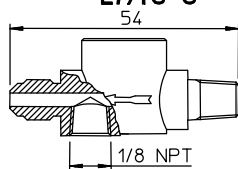
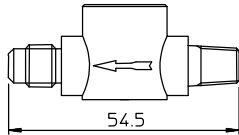
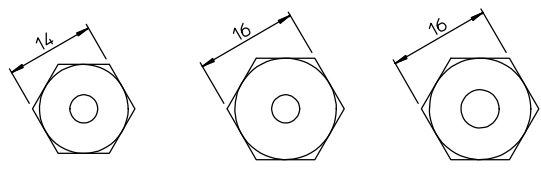
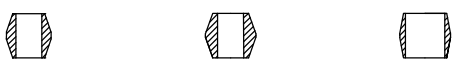
<p align="center"><b>E7/B</b></p>  <p>CONNECTIONS:            Input: G1/4" M            Output : G1/4" M            Orifice diameter: 15 mm            Nut connection:            G1/4" orifice 4 o 6 mm            ogive orifice 4 o 6 mm</p>	<p align="center"><b>E7/B4</b></p>  <p>CONNECTIONS:            Input: G1/4" M            Output : G1/4" M            Orifice diameter: 15 mm            Nut connection:            G1/4" orifice 4 o 6 mm            ogive orifice 4 o 6 mm</p>	<p align="center"><b>E7/BS</b></p>  <p>CONNECTIONS:            Ingresso: G1/8" F            Uscita : R1/8" M            Foro di passaggio: 15 mm</p>	<p align="center"><b>E7/C</b></p>  <p>CONNECTIONS:            Input: R1/8" M            Output : G1/8" F            Orifice diameter: 15 mm</p>
<p align="center"><b>E7/F</b></p>  <p>CONNECTIONS:            Input: R1/8" M            Output : G1/4" M            Orifice diameter: 15 mm            Nut connection:            G1/4" orifice 4 o 6 mm            ogive orifice 4 o 6 mm</p>	<p align="center"><b>E7/L</b></p>  <p>CONNECTIONS:            Input: G1/8" F            Output : G1/8" F            Orifice diameter: 15 mm</p>	<p align="center"><b>E7/L4</b></p>  <p>CONNECTIONS:            Input: G1/8" F            Output : G1/8" F            Orifice diameter: 4 mm</p>	<p align="center"><b>E7/O</b></p>  <p>CONNECTIONS:            Input: G1/8" M            Output : G1/8" M            Orifice diameter: 15 mm            Nut connection:            G1/8" orifice 4 mm            ogive orifice 4 mm</p>
<p align="center"><b>E7/R</b></p>  <p>CONNECTIONS:            Input: M8x1 F            Output : G1/4" M            Orifice diameter: 2 mm            Nut connection:            G1/4" orifice 4 or 6 mm            ogive orifice 4 or 6 mm</p>	<p align="center"><b>E7/T</b></p>  <p>CONNECTIONS:            Input: R1/8" M            Output: G1/8" M            Orifice diameter: 15 mm            Nut connection:            G1/8" orifice 4 mm            ogive orifice 4 mm</p>	<p align="center"><b>E7/TS</b> 54</p>  <p>CONNECTIONS:            Input: R1/8" M            Output: G1/8" M            Orifice diameter: 15 mm            Nut connection:            G1/8" orifice 4 mm            ogive orifice 4 mm</p>	<p align="center"><b>E7/L-US</b></p>  <p>CONNECTIONS:            Input: 1/8" NPT F            Output: 1/8" NPT F            Orifice diameter: 15 mm</p>
<p align="center"><b>E7/T-US</b></p>  <p>CONNECTIONS:            Input: 1/8" NPT M            Output: 3/8-24 M            Orifice diameter: 15 mm</p>	<p align="center"><b>E7/TS-US</b> 54.5</p>  <p>CONNECTIONS:            Input: 1/8" NPT M            Output: 7/16-20 M            Orifice diameter: 15 mm</p>	<p align="center"><b>E7/US</b></p>  <p>CONNECTIONS:            Input: 1/8" NPT M            Output: 1/8" NPT F            Orifice diameter: 15 mm</p>	<p align="center"><b>E7/TS-U</b> 48</p>  <p>CONNECTIONS:            Input: 1/8" NPT M            Output: 1/8" NPT F            Orifice diameter: 15 mm</p>
<p align="center"><b>E7/TS-S</b> 54</p>  <p>CONNECTIONS:            Input: 1/8" NPT M            Output: 3/8-24 M            Orifice diameter: 15 mm</p>	<p align="center"><b>E7/T-U</b></p>  <p>CONNECTIONS:            Input: 1/8" NPT M            Output: 7/16-20 M            Orifice diameter: 15 mm</p>	 <p>Nut: G1/8" orifice 4 mm    Nut: G1/4" orifice 4 mm    Nut: G1/4" orifice 6 mm            Ogive: orifice 4 mm    Ogive: orifice 4 mm    Ogive: orifice 6 mm</p> 	

## INSTALLATION

- Respect the applicable national and European standards (e.g. EN 60335-1) regarding electrical safety.
- Even in the versions without earth conductor the installation must ensure the valve body connection to earth to guarantee adequate protection against the risk of electric shock (EN 60335-1).
- Assemble the valve to the installation so that the arrow on the valve body has the same direction as the fuel flow.
- During the assembly of the valve to the installation piping, do not twist on the sheath but on the valve body.
- Make sure that no foreign matters have entered the valve body.
- Always fit a filter to the valve inlet with a mesh section not exceeding 0.5 mm.
- Ensure a perfect connection between the valve earth conductor and the earth of the installation.
- Make sure that the max. fuel input pressure never exceeds the value appearing on the label.

## CHECKING AT START

Check the valve before the first start, after any overhaul or a long period of non-operation of the system. In particular, check the valve seal where the supply piping is connected to the valve; check the valve opening and closing according to the electrical signal received by the solenoid.

## DIRECTIONS FOR THE REPLACEMENT OF THE SOLENOID

To replace the solenoid, proceed as follows:

- switch off the main switch providing supply voltage to the system;
- remove the stop ring;
- remove the solenoid from the valve sheath;
- insert the new solenoid and proceed in the opposite way to assemble the valve.

## TYPE REFERENCE

**E7 / LS \* A 3C 230/50**

Type

Body type

Type	Input connection	Output connection	Orifice diameter
B	G1/4"M	G1/4"M	1.5 mm
B4	G1/4"M	G1/4"M	4 mm
BS	G1/8"F	R1/8"M	1.5 mm
C	R1/8"M	G1/8"F	1.5 mm
F	R1/8"M	G1/4"M	1.5 mm
L	G1/8"F	G1/8"F	1.5 mm
L4	G1/8"F	G1/8"F	4 mm
O	G1/8"M	G1/8"M	1.5 mm
R	M8X1 F	G1/4"M	2 mm
T	R1/8"M	G1/8"M	1.5 mm
TS	R1/8"M	G1/8"M	1.5 mm

Supply Voltage

Wiring type

Type	Description
2C	Connection with two core cable -IP65.
3C	Connection with three core cable - IP65.
FP	Connection with flat fast-on
FD	Connection with fast-on for plug DIN 43650-IP 65.

Winding type

Type	Description
A	Supply in alternate current
C	Supply in direct current

UL APPROVED VERSIONS

**E7 / L-US \* A 2F 120/60**

Type \_\_\_\_\_

Body type \_\_\_\_\_

Type	Input connection	Output connection	Orifice diameter
L-US	1/8" NPT F	1/8" NPT F	1.5 mm
T-US	1/8" NPT M	3/8-24 M	1.5 mm
TS-US	1/8" NPT M	7/16-20 M	1.5 mm
US	1/8" NPT M	1/8" NPT F	1.5 mm
TS-U	1/8" NPT M	1/8" NPT F	1.5 mm
TS-S	1/8" NPT M	3/8-24 M	1.5 mm
T-U	1/8" NPT M	7/16-20 M	1.5 mm

**Supply voltage**

Type	Description
120/60	120 Vac 60 Hz
230/60	230 Vac 60 Hz

**Wiring type**

Type	Description
2F	Connection with two cable - IP65

**Winding type**

Type	Description
A	Supply in alternate current

**BRAHMA S.p.A.**

Via del Pontiere, 31  
37045 Legnago (VR)

Tel. +39 0442 635211 - Telefax +39 0442 25683

<http://www.brahma.it>

E-mail : [brahma@brahma.it](mailto:brahma@brahma.it)

08/07/30 Subject to amendments without notice